

**Bill of materials**

**+Engino® Models 3D Viewer**

Load Engino® models, rotate, zoom and explode to see how the model can be assembled.



Engino kidCAD



**brand awards**



**INVENTOR girl**

**build.  
play.  
learn.**



**20**  
★ models  
to build

**4** models printed instructions included

product code: **IG20**

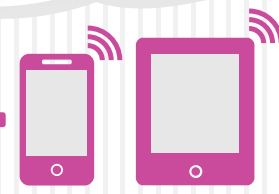

**3D interactive instructions**  
to download on your smart device



**! WARNING:**  
CHOKING HAZARD - Small parts.  
Not for children under 3 yrs.



Engino.net Ltd | P.O.Box 72100, 4200 Limassol, Cyprus, European Union | Tel.: +357 25821960 | Fax: +357 25821961 | Email: info@engino.com | Website: www.engino.com

© Copyright 2016 Engino.net Ltd. All Rights Reserved.



**6-12+** Made in **CYPRUS EU**

Building tips

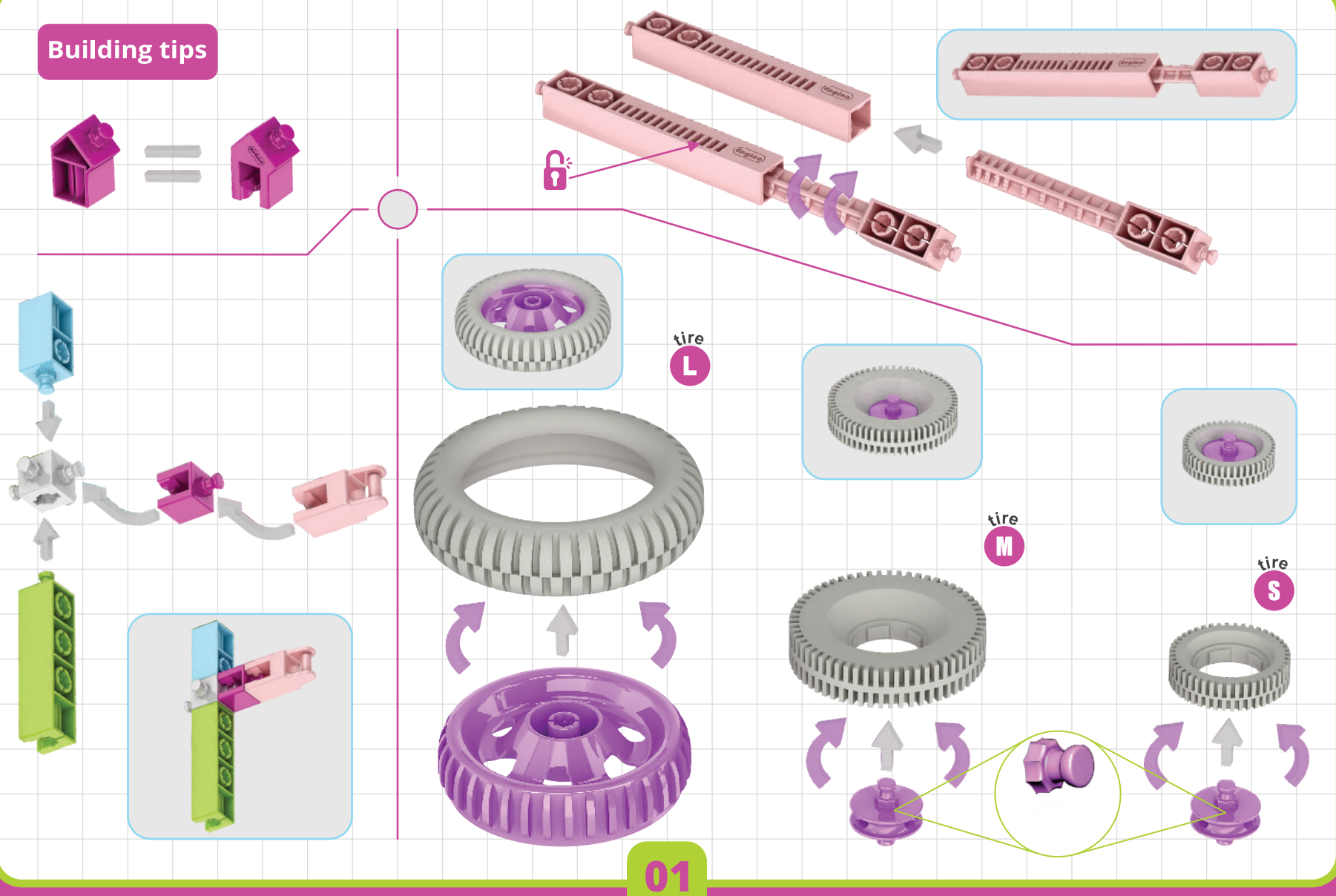

giraffe

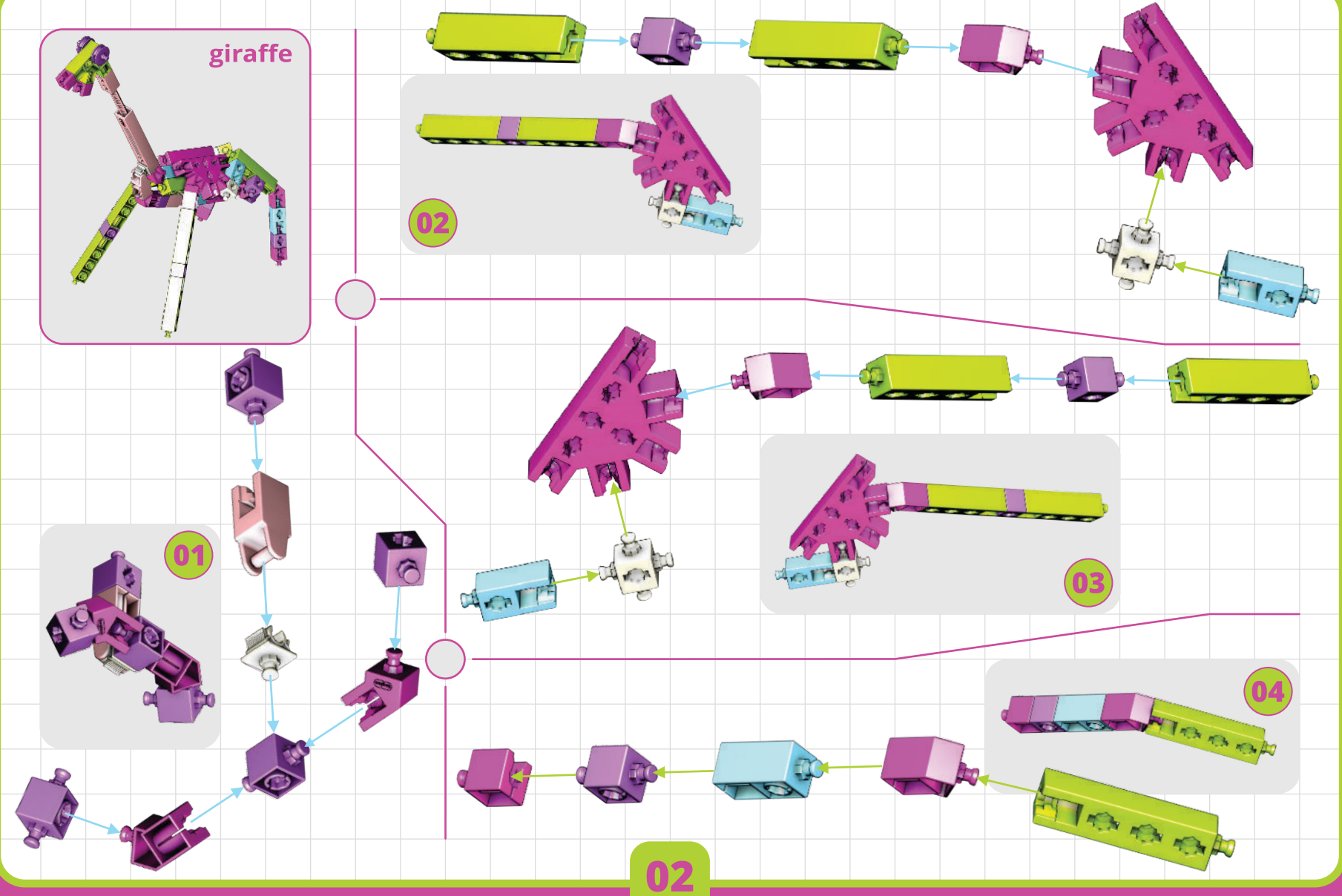

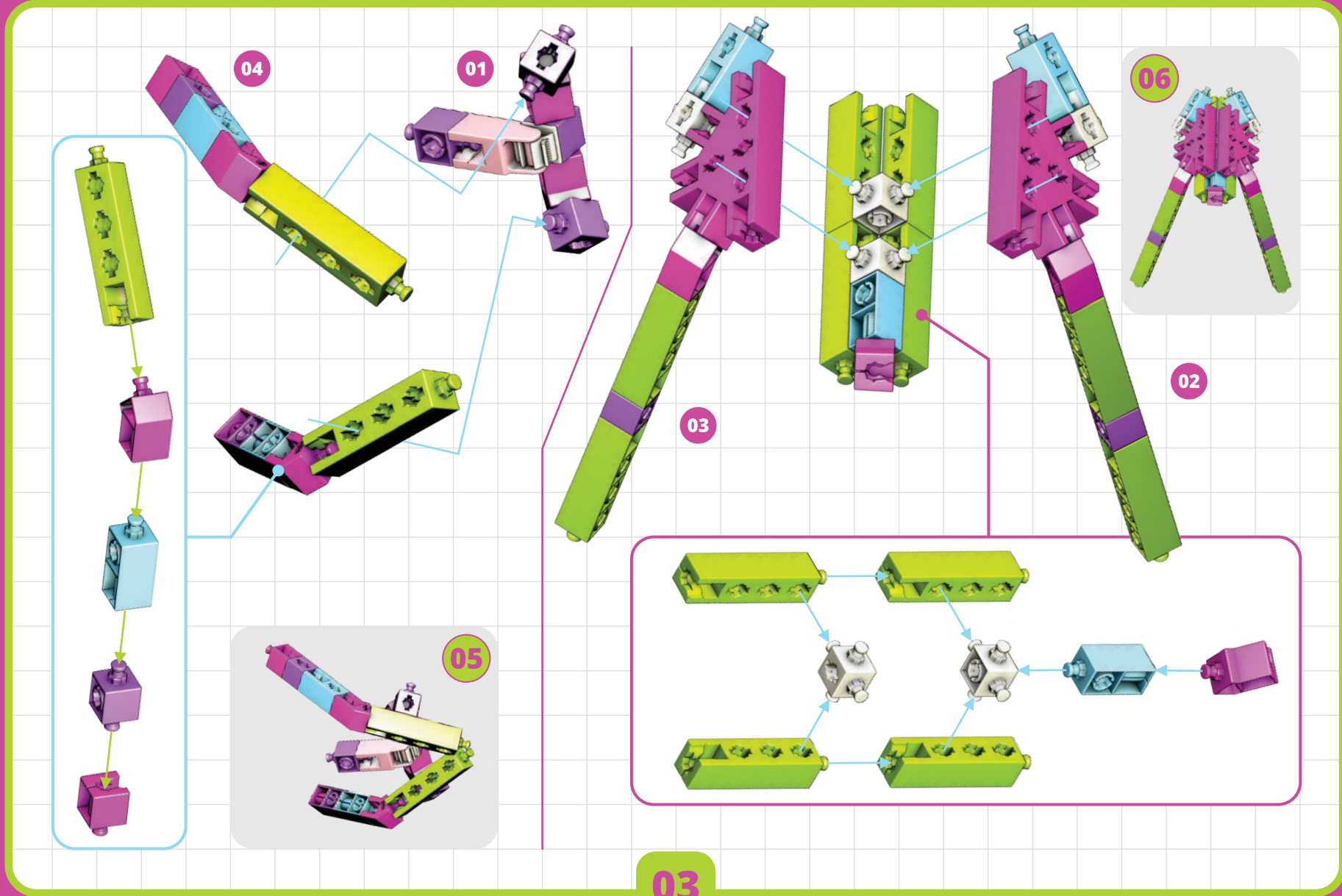

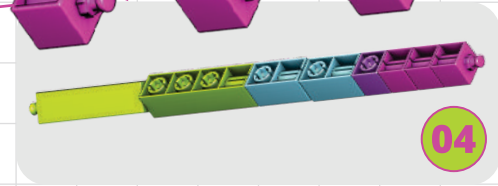
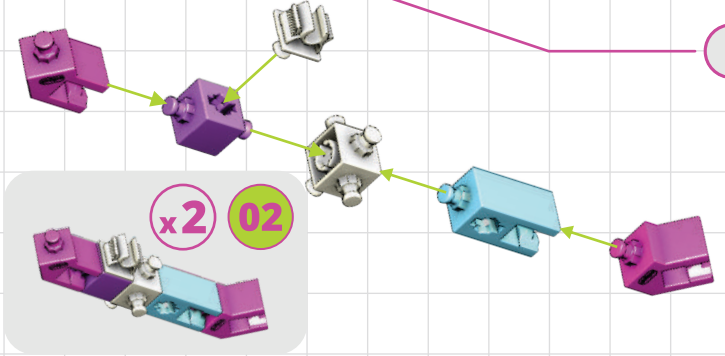
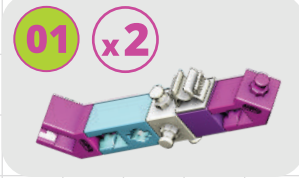
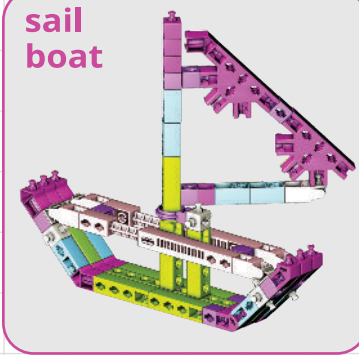

05

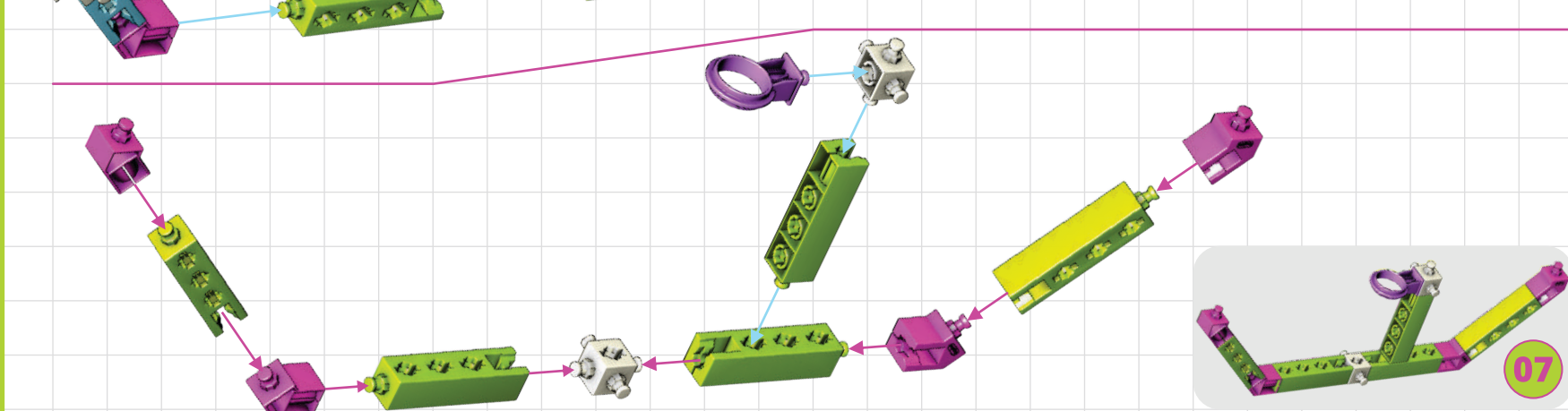
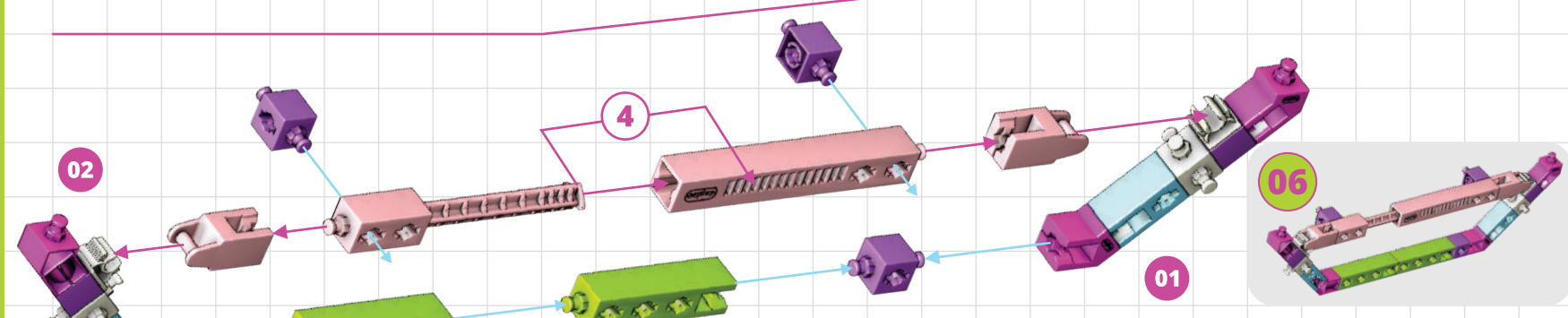
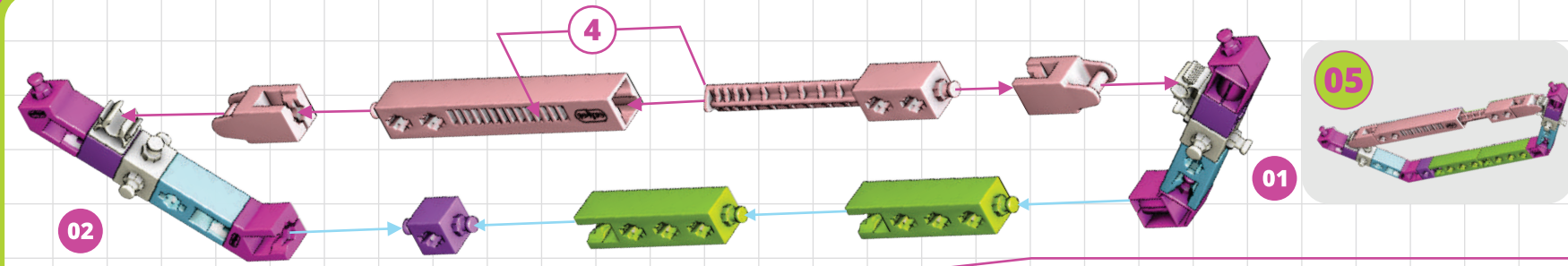

06

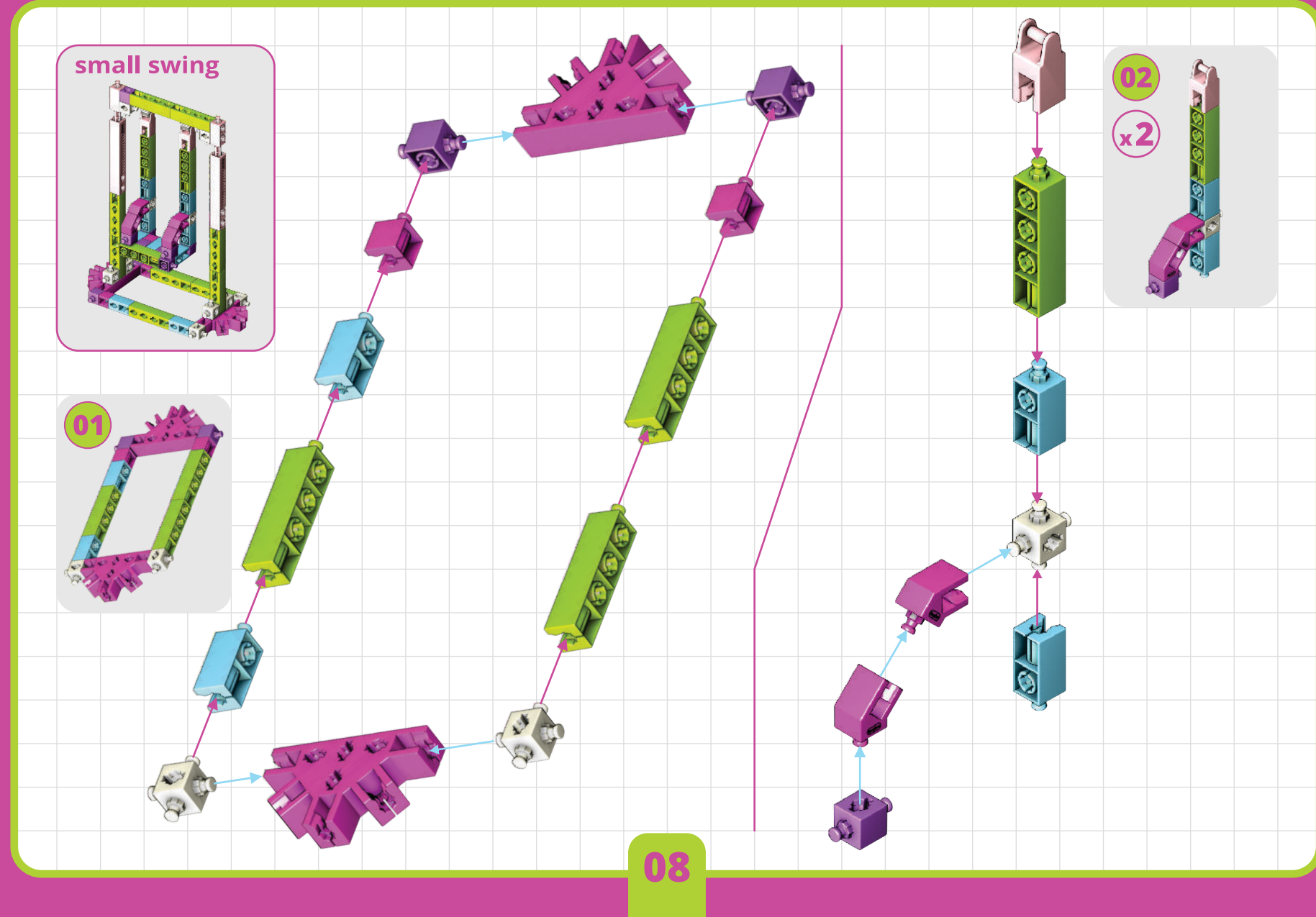
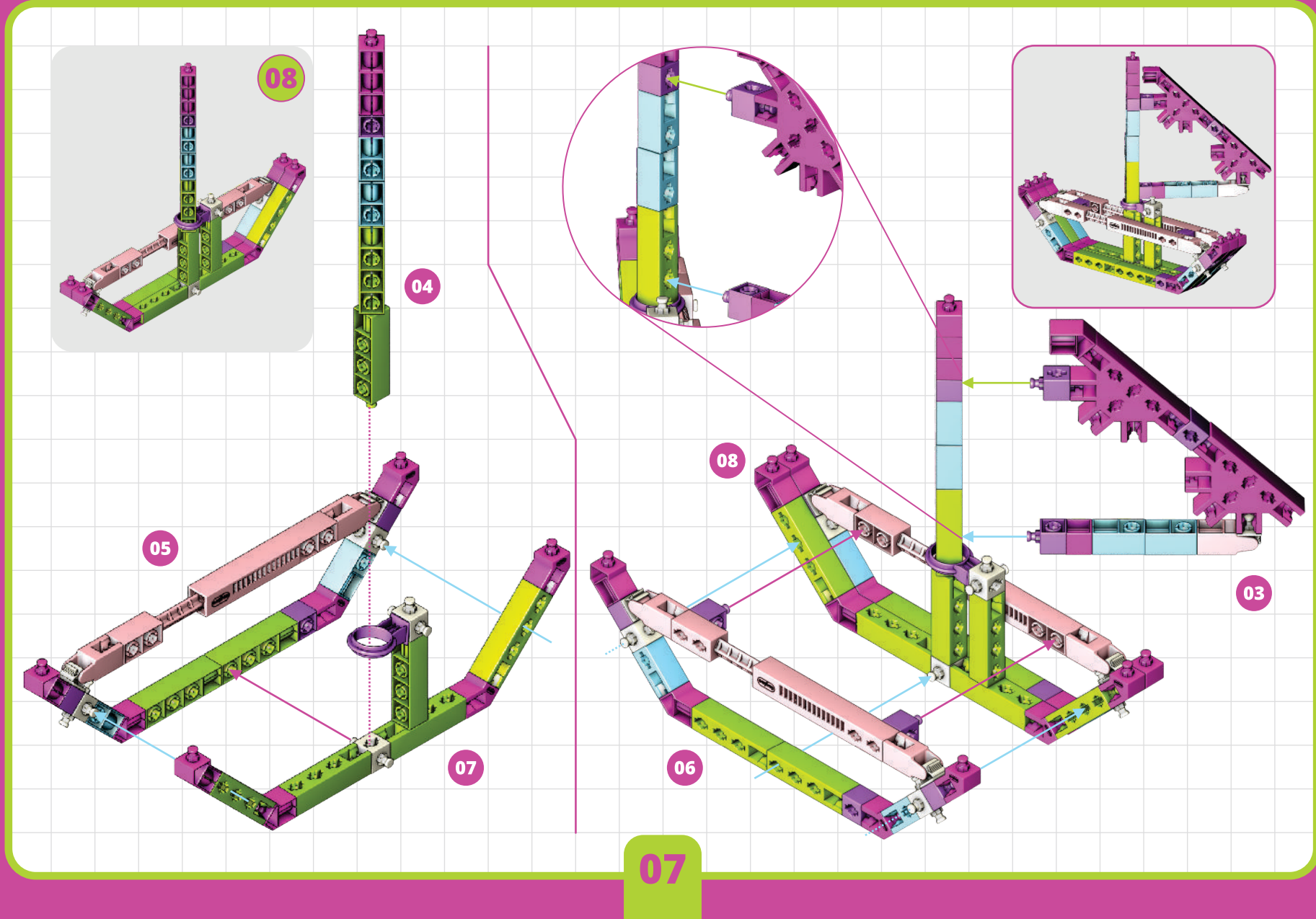

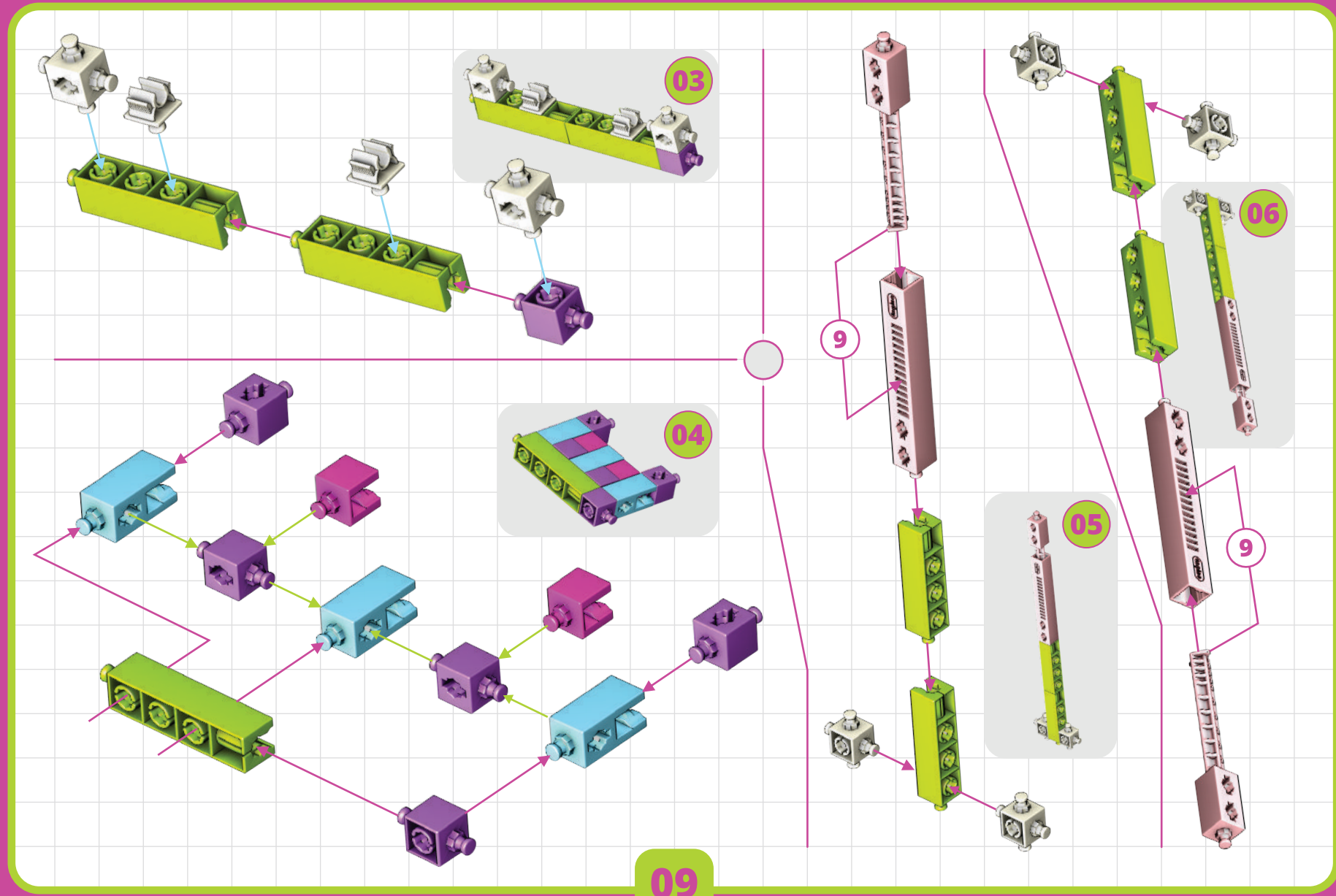

09

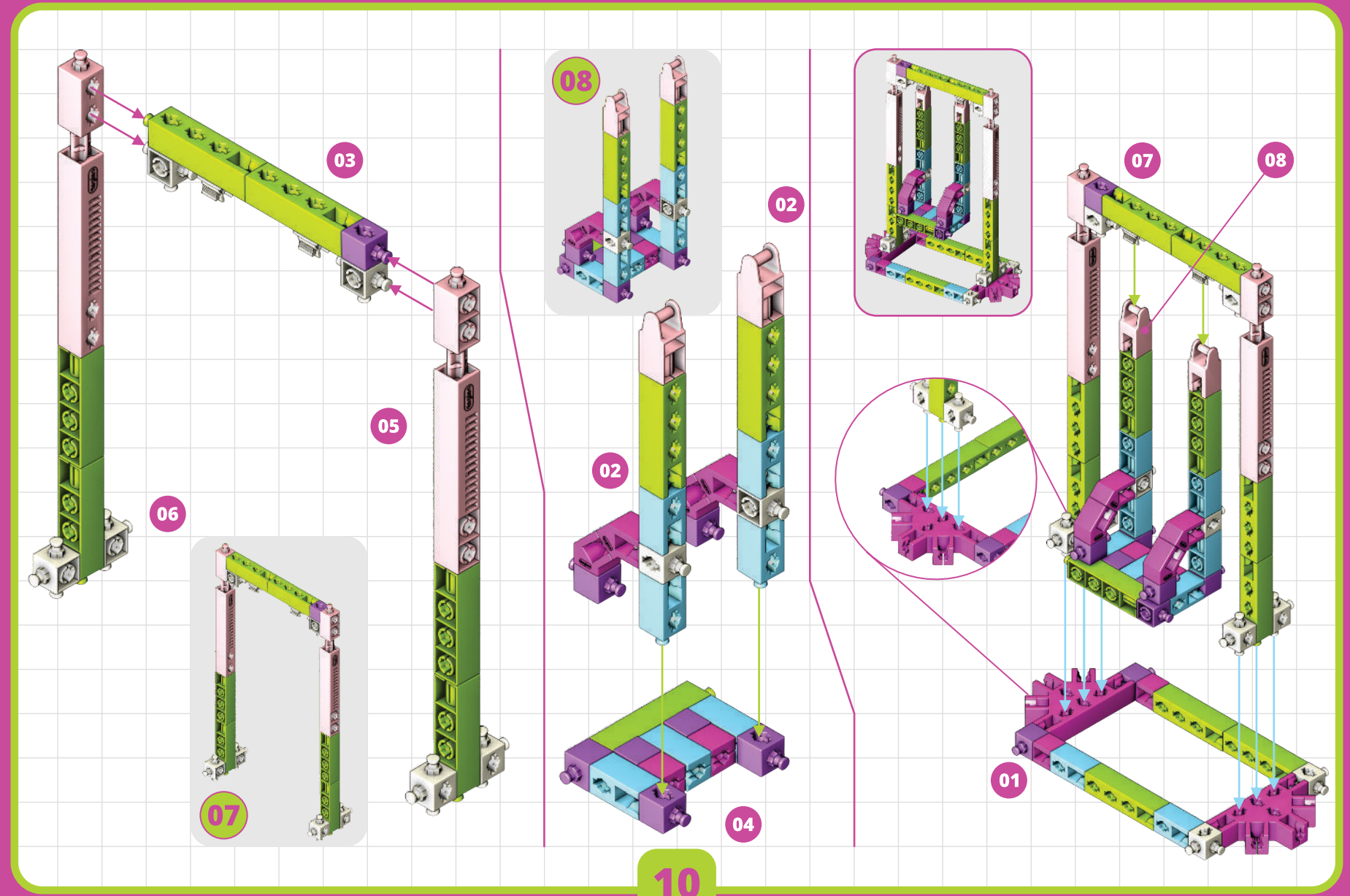

10

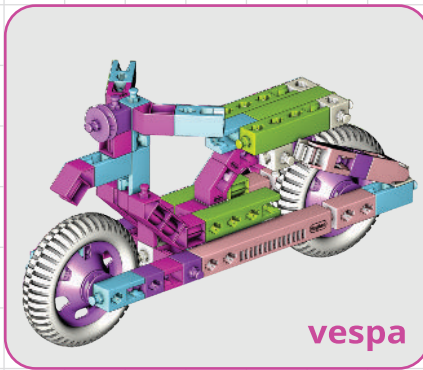

vespa



01

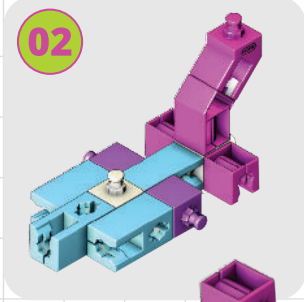

02

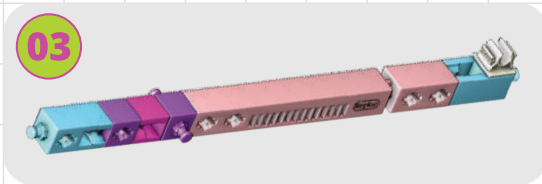

03

12

11



04

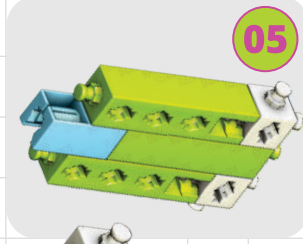

05



06

x2

tire L

12

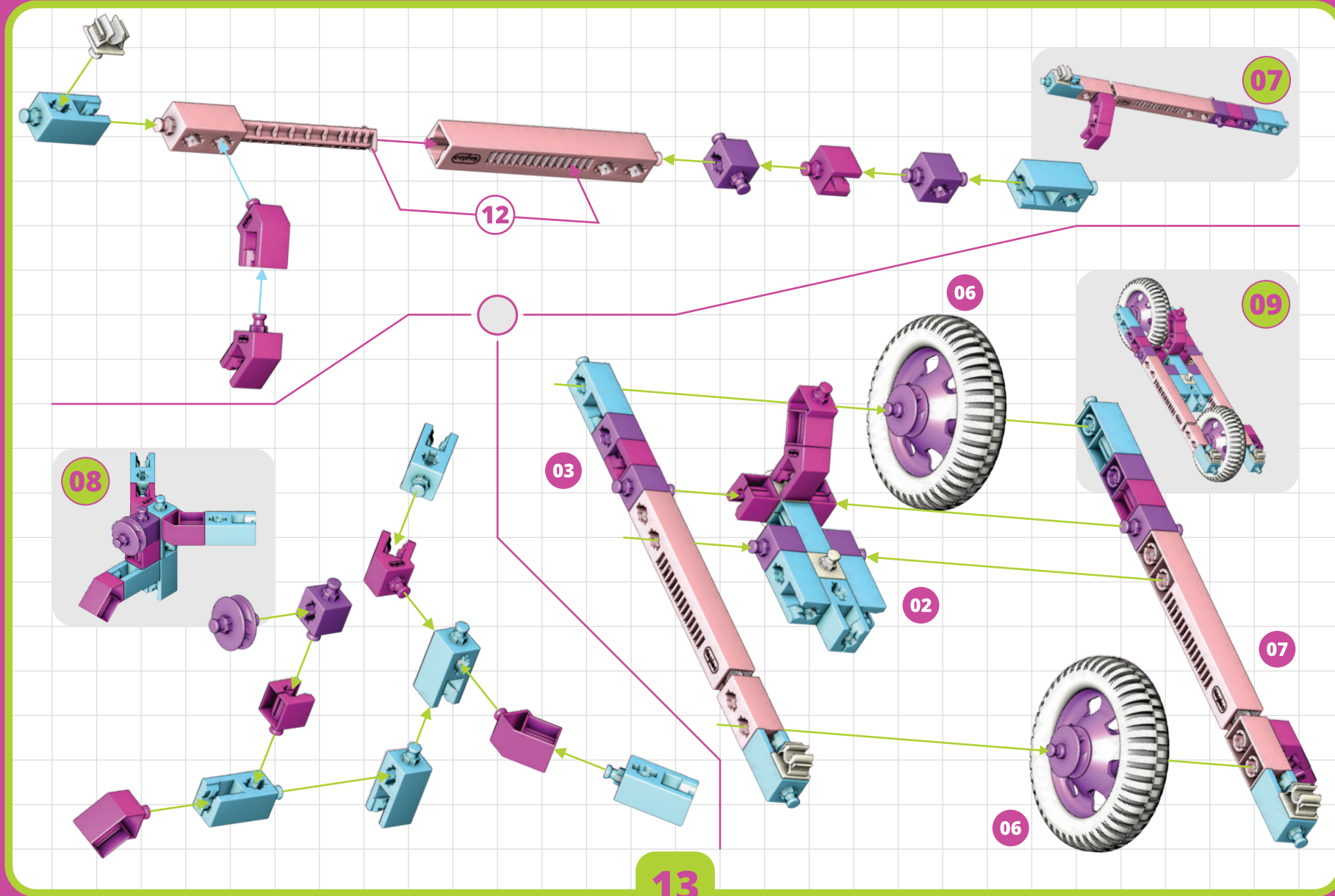

13

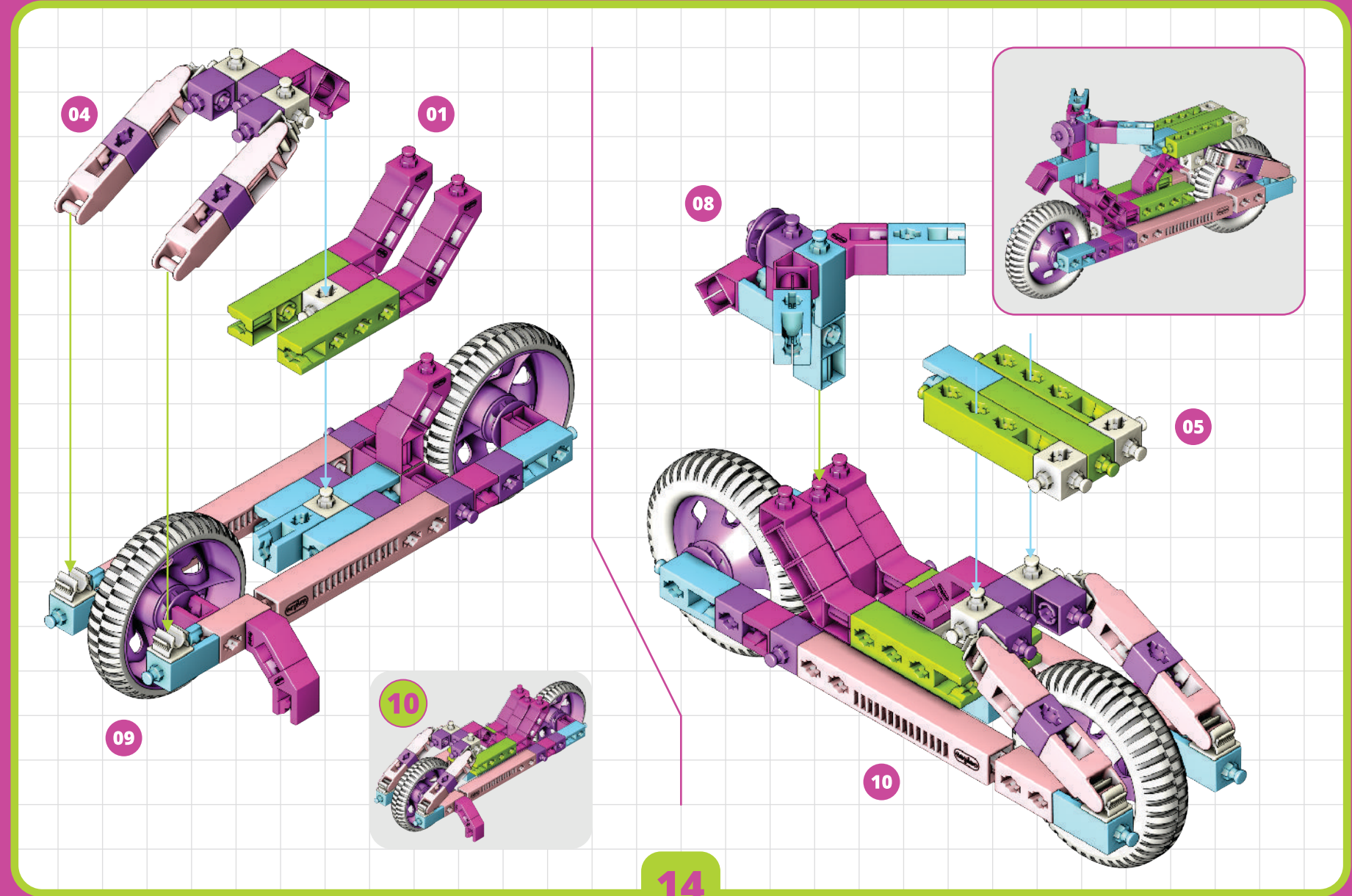

14